

RIGID AND FLEXIBLE OPTICAL ENDOSCOPES



RIGID OPTICAL ENDOSCOPES

Clear, sharp, bright!



Rigid endoscopes are particularly robust and are designed for heavy-duty industrial use. With the rod lens system, these reliably deliver clear, sharp, and bright images and impress with maximum image sharpness right into the margins combined with the best possible field of view. Rigid endoscopes essentially consist of an optical system, mechanics, and a light guide system. The metal sheath and the special glass endpiece at the tip make the endoscope extremely resistant to damage and wear and ensure optimal protection of the optical part.

Special Features:

- Pressure resistant up to +5 bar (in air)
- Maximum stability under load thanks to metal sheaths
- Resistant to oil, fuel, and solvents
- Temperature resistant up to 150 °C (and above)
- Available in the 1.6 mm to 10 mm range

Special image properties:

- Optimal image quality – clear, sharp, bright
- True-color images
- Built-in fiber optic light guide

Diameters 1.6 and 1.9 mm

Diameter	Length	Direction of View	Field of View	Product No.
1.6 mm	60 mm	0°	65°	2110-00065-16060
1.6 mm	60 mm	30°	65°	2110-30065-16060
1.6 mm	100 mm	0°	65°	2110-00065-16100
1.6 mm	100 mm	30°	65°	2110-30065-16100
1.6 mm	175 mm	0°	65°	2110-00065-16175
1.6 mm	175 mm	30°	65°	2110-30065-16175
1.9 mm	60 mm	0°	65°	2110-00065-19060
1.9 mm	60 mm	30°	65°	2110-30065-19060
1.9 mm	100 mm	0°	65°	2110-00065-19100
1.9 mm	100 mm	30°	65°	2110-30065-19100
1.9 mm	175 mm	0°	65°	2110-00065-19175
1.9 mm	175 mm	30°	65°	2110-30065-19175

Diameters 2.4 and 2.7 mm

Diameter	Length	Direction of View	Field of View	Product No.
2.4 mm	110 mm	0°	70°	2110-00070-24110
2.4 mm	110 mm	30°	70°	2110-30070-24110
2.4 mm	110 mm	70°	70°	2110-70070-24110
2.7 mm	110 mm	0°	80°	2110-00080-27110
2.7 mm	110 mm	30°	80°	2110-30080-27110
2.7 mm	110 mm	70°	80°	2110-70080-27110
2.7 mm	140 mm	0°	80°	2110-00080-27140
2.7 mm	140 mm	30°	80°	2110-30080-27140
2.7 mm	140 mm	70°	80°	2110-70080-27140
2.7 mm	175 mm	0°	80°	2110-00080-27175
2.7 mm	175 mm	30°	80°	2110-30080-27175
2.7 mm	175 mm	70°	80°	2110-70080-27175
2.7 mm	240 mm	0°	80°	2110-00080-27240
2.7 mm	240 mm	30°	80°	2110-30080-27240
2.7 mm	240 mm	70°	80°	2110-70080-27240
2.7 mm	300 mm	0°	80°	2110-00080-27300
2.7 mm	300 mm	30°	80°	2110-30080-27300
2.7 mm	300 mm	70°	80°	2110-70080-27300

Diameter 4.0 mm

Diameter	Length	Direction of View	Field of View	Product No.
4.0 mm	50 mm	0°	80°	2110-00080-40050
4.0 mm	50 mm	30°	80°	2110-30080-40050
4.0 mm	50 mm	70°	80°	2110-70080-40050
4.0 mm	50 mm	0°	105°	2110-00105-40050
4.0 mm	50 mm	30°	105°	2110-30105-40050
4.0 mm	50 mm	70°	105°	2110-70105-40050
4.0 mm	100 mm	0°	80°	2110-00080-40100
4.0 mm	100 mm	30°	80°	2110-30080-40100
4.0 mm	100 mm	70°	80°	2110-70080-40100
4.0 mm	100 mm	0°	105°	2110-00105-40100
4.0 mm	100 mm	30°	105°	2110-30105-40100
4.0 mm	100 mm	70°	105°	2110-70105-40100

4.0 mm	175 mm	0°	80°	2110-00080-40175
4.0 mm	175 mm	0°	105°	2110-00105-40175
4.0 mm	175 mm	30°	80°	2110-30080-40175
4.0 mm	175 mm	30°	105°	2110-30105-40175
4.0 mm	175 mm	70°	80°	2110-70080-40175
4.0 mm	175 mm	70°	105°	2110-70105-40175
4.0 mm	300 mm	0°	80°	2110-00080-40300
4.0 mm	300 mm	0°	105°	2110-00105-40300
4.0 mm	300 mm	30°	80°	2110-30080-40300
4.0 mm	300 mm	30°	105°	2110-30105-40300
4.0 mm	300 mm	70°	80°	2110-70080-40300
4.0 mm	300 mm	70°	105°	2110-70105-40300
4.0 mm	690 mm	0°	105°	2110-00105-40690
4.0 mm	690 mm	30°	105°	2110-30105-40690
4.0 mm	690 mm	70°	105°	2110-70105-40690

Diameter 5.5mm

Diameter	Length	Direction of View	Field of View	Product No.
5.5 mm	300 mm	0°	80°	2110-00080-55300
5.5 mm	300 mm	0°	105°	2110-00105-55300
5.5 mm	300 mm	30°	80°	2110-30080-55300
5.5 mm	300 mm	30°	105°	2110-30105-55300
5.5 mm	300 mm	70°	80°	2110-70080-55300
5.5 mm	300 mm	70°	105°	2110-70105-55300
5.5 mm	430 mm	0°	80°	2110-00080-55430
5.5 mm	430 mm	0°	105°	2110-00105-55430
5.5 mm	430 mm	30°	80°	2110-30080-55430
5.5 mm	430 mm	30°	105°	2110-30105-55430
5.5 mm	430 mm	70°	80°	2110-70080-55430
5.5 mm	430 mm	70°	105°	2110-70105-55430
5.5 mm	690 mm	0°	80°	2110-00080-55690
5.5 mm	690 mm	0°	105°	2110-00105-55690
5.5 mm	690 mm	30°	80°	2110-30080-55690
5.5 mm	690 mm	30°	105°	2110-30105-55690
5.5 mm	690 mm	70°	80°	2110-70080-55690
5.5 mm	690 mm	70°	105°	2110-70105-55690

Diameter 6.0mm

Diameter	Length	Direction of View	Field of View	Product No.
6.0 mm	190 mm	90°	70°	2110-90070-60190
6.0 mm	330 mm	90°	70°	2110-90070-60330
6.0 mm	540 mm	90°	70°	2110-90070-60540
6.0 mm	190 mm	120°	70°	2110-12070-60190
6.0 mm	330 mm	120°	70°	2110-12070-60330
6.0 mm	540 mm	120°	70°	2110-12070-60540

Diameter 10.0mm

Diameter	Length	Direction of View	Field of View	Product No.
10 mm	314 mm	0°	80°	2110-00080-99314
10 mm	314 mm	30°	80°	2110-30080-99314

Protective tubes available for rigid endoscopes.

FLEXIBLE OPTICAL ENDOSCOPES

Flexible access in angled objects



Flexible endoscopes – or fiberscopes – are easy to use and extremely flexible. Fiberscopes enable access to convoluted and sharply angled spaces, channels or pipes, that would otherwise be invisible to the human eye.

The fiberscope's flexibility is based on its unique image guide system that consists of optical fibers. These optical fibers transmit the image from the lens to the eyepiece.

When combined with a powerful light source, our high quality optical system offers you excellent, sharp images that allows reliable assessment of the object to be inspected.

The metal sheath and the special glass endpiece at the tip make the endoscope extremely resistant to damage and wear and ensure optimal protection of the optical part.

Special Features:



- With outer tungsten braiding
- With focus ring
- Easy to use with one hand
- High-resolution image guide





Fiberscope Diameters 2.5 and 3.8mm





Diameter	Length	Angle of View	Deflection up/down	Product No.
2.5 mm	700 mm	75°	150° / 150°	3100-00075-25700
3.8 mm	700 mm	75°	150° / 150°	3100-00075-38700





ACCESSORIES

Cameras and Documentation Systems	Product No.	
	4131-00000-00001	Vcam HD camera head incl. data cable, white light LED light source, alternatively UV-LED light source
	4131-00000-00002	VCam HD+ Documentation System VCam HD plus 3.5" system monitor Optional accessories VCam HD+ system light source incl. docking station
	4133-00000-00002	VCam HD+ System Light Source incl. Docking Station
	4136-00000-00001	Mobile Cam compact camera monitor system
	2132-00000-00014 ... 2132-00000-00035 2132-00000-01835	HD Camera Lens Adaptor fits all cameras, focal lengths 14mm/17mm/21mm/22mm/28mm/35mm/Zoom (18-35mm)

Universal Light Sources	Product No.	
	7630-00000-11112	Stationary LED Light Source Illumination 900,000 Lux Color temperature 5,500 K Power supply via a separate power supply unit Robust metal housing
	7630-00000-11111	Battery-powered Light Source - 5 Watt Intensity 3x adjustable Color temperature 6,000 K Illumination 80,000 Lux
	7630-00000-11113	Inductive Light Source - 5 Watt Intensity 3x adjustable Color temperature 6,000 K Illumination 80,000 Lux

Light Guides	Product No.	
	7630-00000-11114	Fiber Optic Light Guide, length 180 cm outer diameter 10 mm, active light guide 3.5 mm
	7630-00000-11115	Fiber Optic Light Guide, length 250 cm outer diameter 10 mm, active light guide 3.5 mm
	7630-00000-11116	Fiber Optic Light Guide, length 180 cm Light connection: 90° angled on the endoscope outer diameter 10 mm, active light guide 3.5 mm
	7630-00000-11117	Fiber Optic Light Guide, length 250 cm Light connection: 90° angled on the endoscope outer diameter 10 mm, active light guide 3.5 mm

Monitors	Product No.	
	7930-00000-00013	13" Industrial HD Monitor, metal housing
	7930-00000-00015	15" Industrial HD Monitor, metal housing
	7930-00000-00017	17" Industrial HD Monitor
	7930-00000-00019	19" Industrial HD Monitor

Cases	Product No.	
	7630-00000-00003	For 4 rigid endoscopes up to 350mm working length and accessories
	7630-00000-00001	For 3 rigid endoscopes up to 200mm working length and accessories, e.g. light source
	7630-00000-00004	For Flexible Endoscope FE38700A70 or FE25700A7 and accessories
	7630-00000-00005	For 1 rigid endoscope up to 200mm working length and USB-HD camera including C-Mount TV Adaptor
	7630-00000-00002	For 1 rigid endoscope up to 700mm working length

Further accessories, endoscope models and versions available on request.

Specifications subject to change.

SYSTEM OVERVIEW

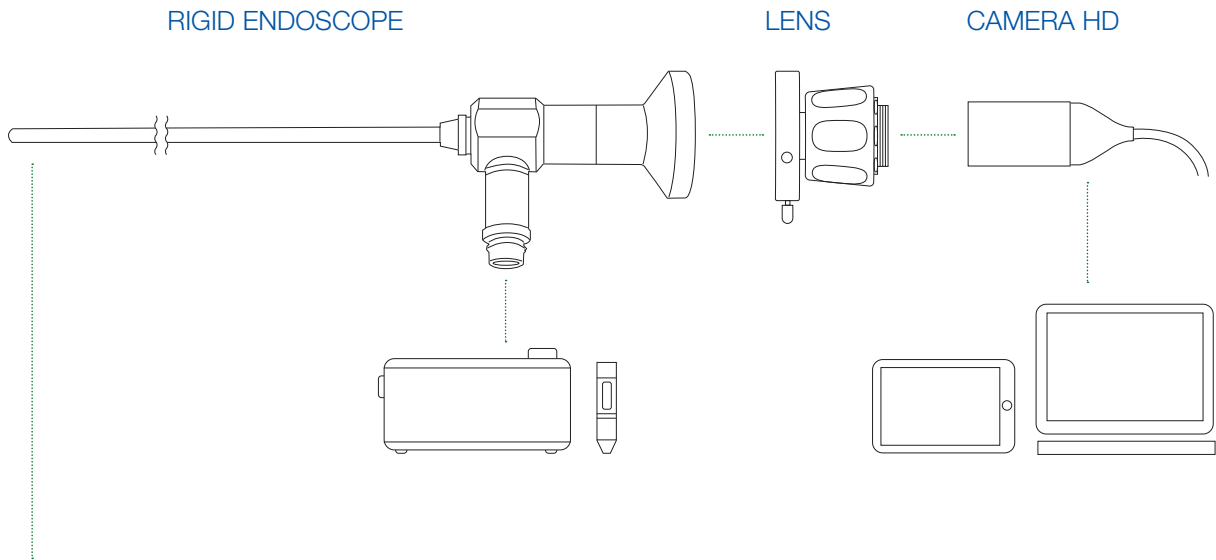

DIRECTIONS OF VIEW

Fixed focal length
Zoom



LIGHT SOURCES

Stationary LED Light Sources
Battery Light Sources
Light Guides

OUTPUT MEDIA / DOCUMENTATION

Tablet
Notebook/PC
Control Monitor VCam HD Plus
Monitor 11", 13", 17" 19"